

LABEL 4-6-7 TUBE Ceiling

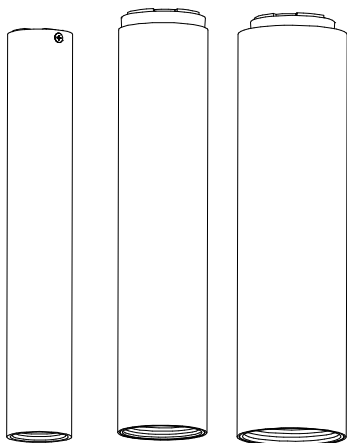

6,8W Sorgente Led / Led source
7,6W Apparecchio / Fixture

COD. 1T9780 / 1T9781 / 1T9782 / 1T9783
COD. 1T9784 / 1T9785 / 1T9786 / 1T9787
COD. 1T9788 / 1T9789 / 1T9790 / 1T9791



8,3W Sorgente Led / Led source
9,2W Apparecchio / Fixture

COD. 1T9768 / 1T9769 / 1T9770 / 1T9771
COD. 1T9772 / 1T9773 / 1T9774 / 1T9775
COD. 1T9776 / 1T9777 / 1T9778 / 1T9779



10W Sorgente Led / Led source
11W Apparecchio / Fixture

COD. 1T9756 / 1T9757 / 1T9758 / 1T9759
COD. 1T9760 / 1T9761 / 1T9762 / 1T9763
COD. 1T9764 / 1T9765 / 1T9766 / 1T9767



220-240V
50/60Hz



1	T	X	X	X	X		
						E	L
						D	A

In caso di dubbi sulla simbologia,
riferirsi al catalogo o al sito web.
*If in doubt the symbols refer
to catalog or website.*

Electronic

DALI Dimmable

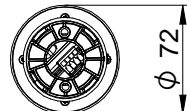
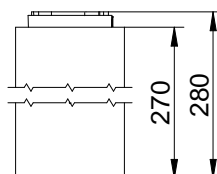
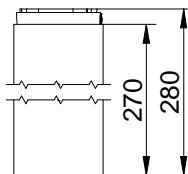
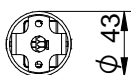
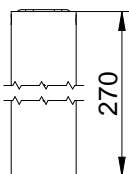
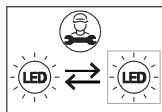
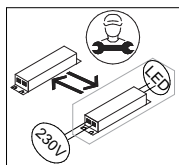

This product contains a light source of energy efficiency class < <https://www.targetti.com/en/Site-Search> >
Questo prodotto contiene una sorgente luminosa di classe di efficienza energetica < <https://www.targetti.com/it/Cerca-nel-sito> >
Ce produit contient une source lumineuse de classe d'efficacité énergétique < <https://www.targetti.com/fr/Chercher-sur-le-site> >
Dieses Produkt enthält eine Lichtquelle der Energieeffizienzklasse < <https://www.targetti.com/de/Auf-der-Seite-suchen> >
Este producto contiene una fuente de luz de clase de eficiencia energética < <https://www.targetti.com/es/Busca-en-el-sitio-web> >

RG1 secondo norma IEC/TR 62778:2014 / RG1 in accordance with IEC/TR 62778:2014

RG1 selon la norme IEC/TR 62778:2014 / RG1 gemäß der norm IEC/TR 62778:2014

RG1 enlight IEC/TR 62778:2014 / RG1 volgens der Norm IEC/TR 62778:2014

RG1 de acordo com norma IEC/TR 62778:2014

- I Lasciare una copia di queste istruzioni al responsabile della manutenzione della installazione.
- GB Please leave a copy of these instructions to the person responsible for the maintenance of the installation.
- F Laisser une copie de ces instructions au responsable de l'entretien du système
- D Bitte übergeben Sie diese Anleitung dem Verantwortlichen für die Wartung der Beleuchtungsanlage.
- S Lämna en kopia av dessa instruktioner till underhållschefen.
- E Entregar una copia de estas instrucciones al responsable de la instalación.
- عربي يرجى ترك نسخة من إرشادات وتعليمات التركيب للفني المسئول عن برنامج الصيانة
- RU Пожалуйста, сохраните копию инструкции у лица, ответственного за обслуживание установленного оборудования.
- 中国 请给负责安装维护的人员保留或转达一份说明书。

- I L'apparecchio deve essere installato da personale qualificato. L'azienda declina ogni responsabilità qualora l'installazione non avvenga secondo le norme vigenti.
- GB This fixture must be installed by a qualified electrician. Targetti is not responsible if its fixtures are not installed according to local safety standards.
- F L'appareil doit être installé par électriciens qualifiés. Targetti ne peut pas être responsable pour toutes les installations qui ne respectent pas les normes de sécurité en vigueur.
- D Diese Leuchte darf nur von qualifiziertem Fachpersonal des Elektrohandwerks installiert werden. Targetti ist nicht verantwortlich, wenn die Montage nicht gemäß der Sicherheitsvorschriften stattfindet.
- S Apparaten ska installeras av kvalificerad personal. Företaget fransäger sig allt ansvar om installationen inte sker enligt gällande föreskrifter.
- E El aparato debe ser instalado por electricistas cualificados. Targetti no se responsabilizara de todas las instalaciones que no respeten las normas da seguridad en vigor.
- عربي الشركة المصنعة لاتحمل اي مسئولية قانونية في حالة عدم تركيب الجهاز حسب الارشادات والمواصفات المعمول بها يجب تركيب هذا الجهاز عن طريق الفني المختص فقط
- RU Сохраните этикетку от оригинальной упаковки на случай возможной будущей рекламыии. 该灯具应由有资质的电工安装；如果灯具没有按照本国的安全规范安装，TARGETTI将不承担相关责任
- 中国 TARGETTI将不承担相关责任

- I Conservare l'etichetta dell'imballo originale per eventuali reclami futuri.
- GB Keep the label of the original packaging for the eventual future claims.
- F Garder l'étiquette de l'emballage original pour éventuelles réclamations futures.
- D Bitte bewahren Sie das Etikett der Originalverpackung für eventuelle zukünftige Reklamationen auf.
- S Håll etiketten på originalförpackningen för eventuella framtida krav.
- E Conservar la etiqueta del embalaje original para posibles reclamaciones.
- عربي يرجى الحفاظ على الملصق الموجود على العبوة الاصلية لاستعمالها في حالة اي تقديم شكوي في المستقبل
- RU Сохраните этикетку от оригинальной упаковки на случай возможной будущей рекламации.
- 中国 请保持好原始包装上的标签

- I Attenzione nell'area di prodotto del sito web - www.targetti.com - potrebbe essere disponibile una versione più aggiornata del presente manuale
- GB Attention in the product area of the website - www.targetti.com - could be available one most updated version of this manual
- F Attention, dans l'aire du produit du site web - www.targetti.com - il pourrait être disponible une version plus récente de ce manuel
- D Zur Beachtung: Bitte überprüfen Sie die Website www.targetti.com nach einer überarbeiteten Version dieser Anleitung.
- S Försiktighet i produkten enligt webbplatsen - www.targetti.com, det kan finnas en mer aktuell version av manualen på produktområdet på web-sidan
- E Para más información acerca del producto puede visitar nuestra página web - www.targetti.com - podría estar disponible una versión más actualizada del presente manual
- عربي انتباه: في صفحة المنتجات على الموقع - www.targetti.com - قد يتوفر إصدار أحدث من هذا الكتيب
- RU АКТУАЛЬНАЯ ВЕРСИЯ ИНСТРУКЦИИ ДОСТУПНА ДЛЯ ЗАГРУЗКИ В РАЗДЕЛЕ PRODUCTS САЙТА www.targetti.com
- 中国 请留意官网的产品介绍栏，可获得产品的最新版本-www.targetti.com

Attenzione! Per gli apparecchi equipaggiati con sistema DALI, tutti i cavi, le connessioni e le attrezzature utilizzate devono essere conformi e adeguate alla relativa tensione di rete; Il segnale DALI potrebbe non essere trasmesso con una bassissima tensione di sicurezza (SELV). Sono disponibili all'indirizzo www.digitalilluminationinterface.org tutte le informazioni generali sul sistema DALI.

Warning! For luminaires equipped with DALI system, all cables, connections and equipment used must comply and adapt to the relative mains voltage; The DALI signal may not be transmitted with a very low safety voltage (SELV). All general information on the DALI system are available at www.digitalilluminationinterface.org.

A TUBE 4 TUBE 6/7

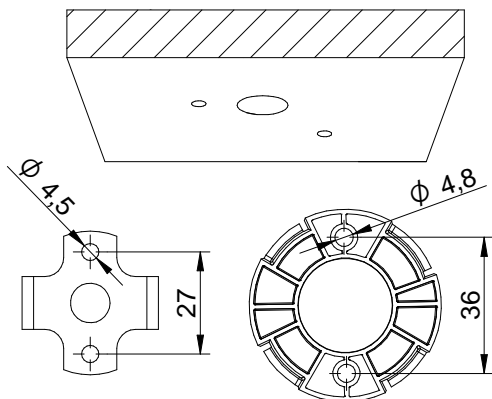
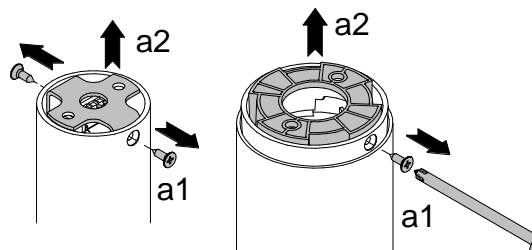

C TUBE 4

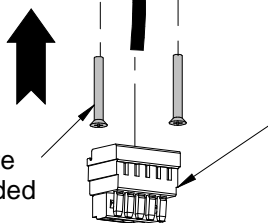
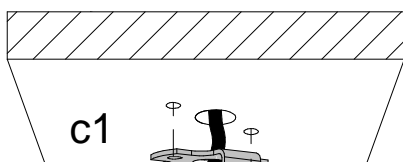

Non fornite
Not provided

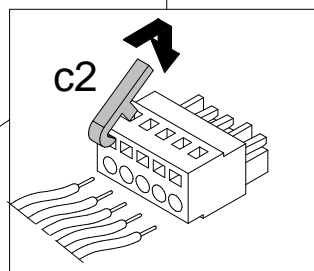

8 - 9mm
2,5mm² Max

E L Electronic

- L = Linea / Line
- ⊕ = Terra / ground
- N = Neutro / neutral

D A DALI Dimmable

- DA = Dimmer dali
- DA = Dimmer dali
- L = Linea / Line
- ⊕ = Terra / ground
- N = Neutro / neutral

TUBE 6/7

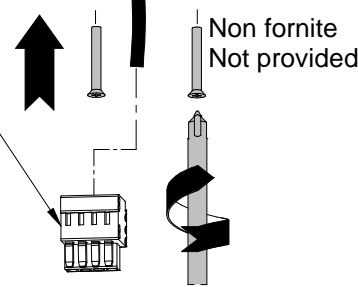
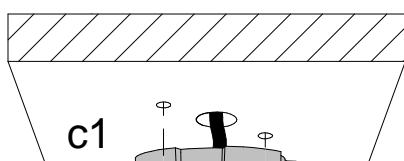

Non fornite
Not provided

E L Electronic

- L = Linea / Line
- N = Neutro / neutral

D A DALI Dimmable

- DA = Dimmer Dali
- DA = Dimmer Dali
- L = Linea / Line
- N = Neutro / neutral

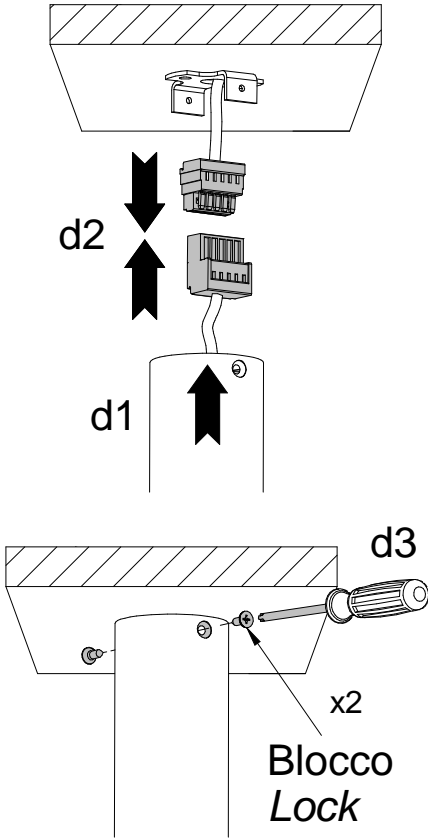
D**TUBE 4****TUBE 6/7**